



Sistema Eurolight

Corredizas y fijas

Window World



**CATALOGO GENERAL DEL SISTEMA
CORREDIZO EUROLIGHT**

ÍNDICE

Generalidades.....	2
Configuraciones posibles.....	2
Secciones de perfiles.....	3
Ensamble:	
Sistema 2 hojas + malla / Sistema 3 carriles.....	6
Sistema 2 hojas + malla + fijo inferior / Sistema 3 carriles.....	6
Sistema 2 hojas + malla + fijo superior / Sistema 3 carriles.....	6
Sistema 3 hojas sin malla / Sistema 3 carriles.....	7
Sistema 3 hojas + malla / Sistema 3 carriles.....	7
Sistema 3 hojas + 2 mallas / Sistema 3 carriles.....	7
Sistema 4 hojas + 2 mallas / Sistema 3 carriles.....	8
Cortes de piso.....	9

GENERALIDADES DEL SISTEMA EUROLIGHT

	Mínimo	Máximo
Alto de la hoja:	350 mm	1500 mm
Ancho de la hoja:		1000 mm

Dimensión del perfil de hoja:	17x57 mm
Dimensión del perfil de marco:	2 rieles: 26.5mm x 54mm 3 rieles: 26.5mm x 78 mm
Peso máximo:	80 kg
Espesor máximo de vidrio:	8 mm

CONFIGURACIONES POSIBLES

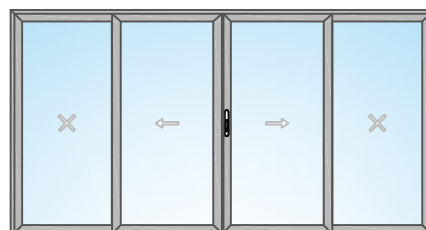
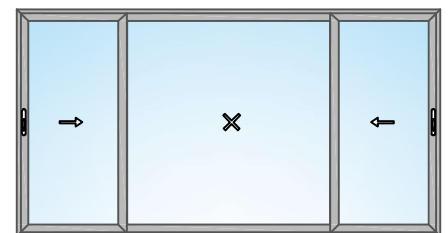
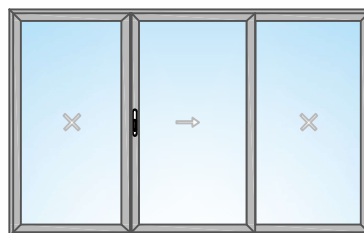
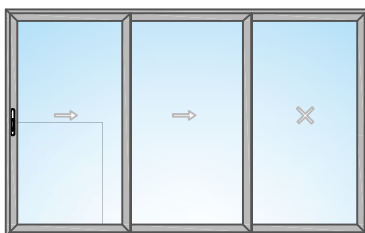
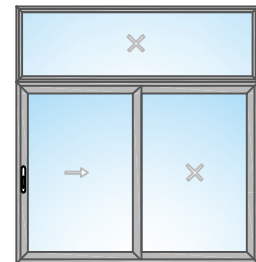
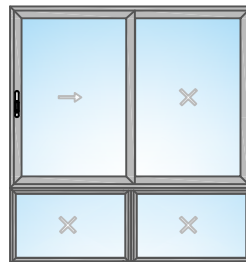
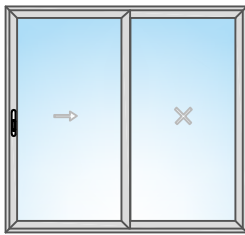

Escala 1:1

Secciones genéricas

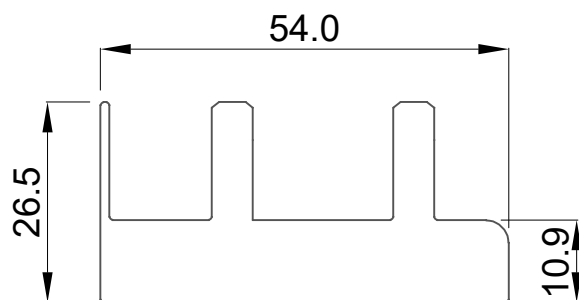

FI-3880
MARCO 2 RIELES

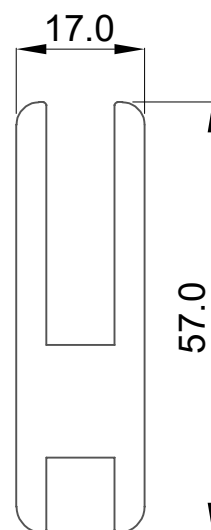

FI-3878
HOJA CORREDIZA

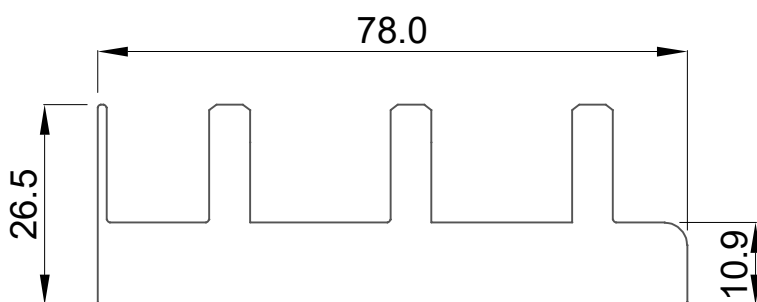

FI-4632
MARCO 3 RIELES

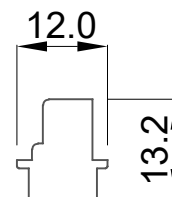

FI-4633
ADAPTADOR
DE MALLA

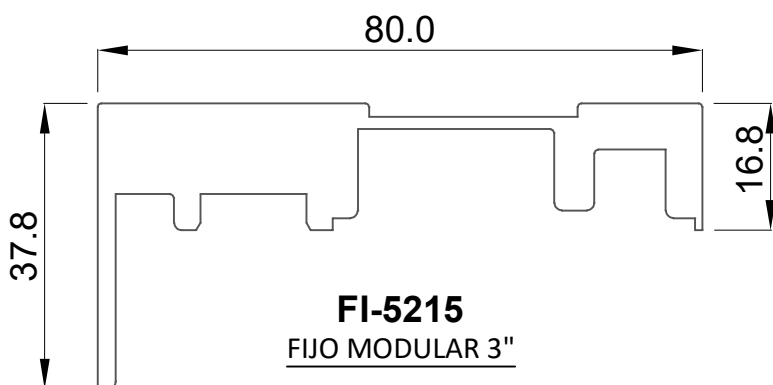

FI-5215
FIJO MODULAR 3"

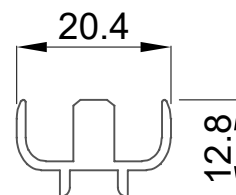

FI-4029
ADAPTADOR DE HOJA

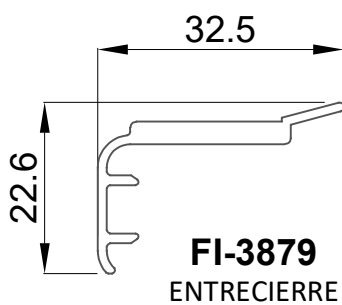

FI-3879
ENTRECIERRE

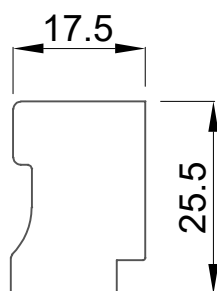

FI-5123
JUNQUILLO

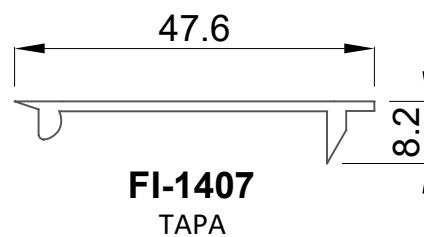

FI-1407
TAPA

Secciones genéricas

Escala 1:2

Sección B-B'

Corte Vertical

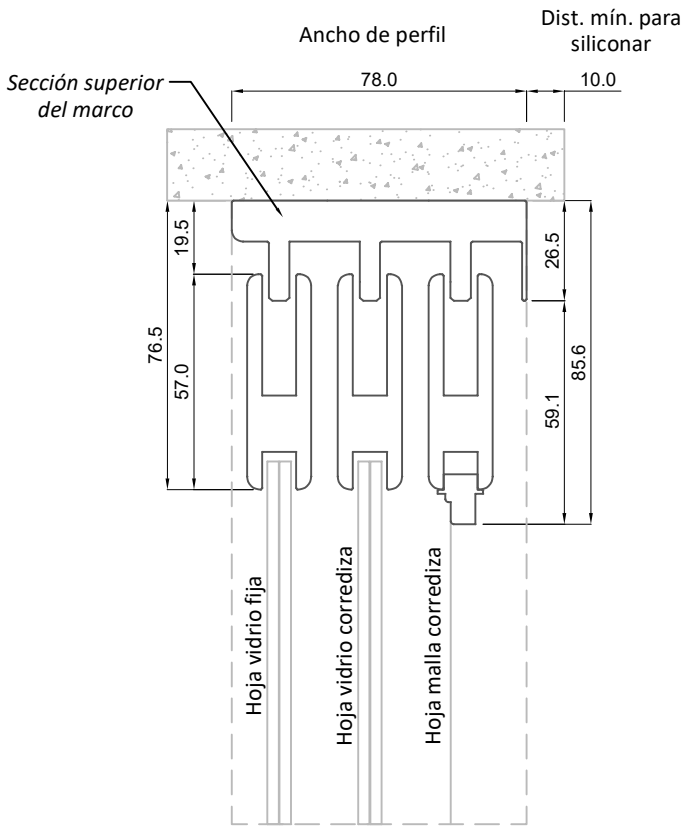

Ventana Genérica 3 Carriles: 2 hojas + 1 malla

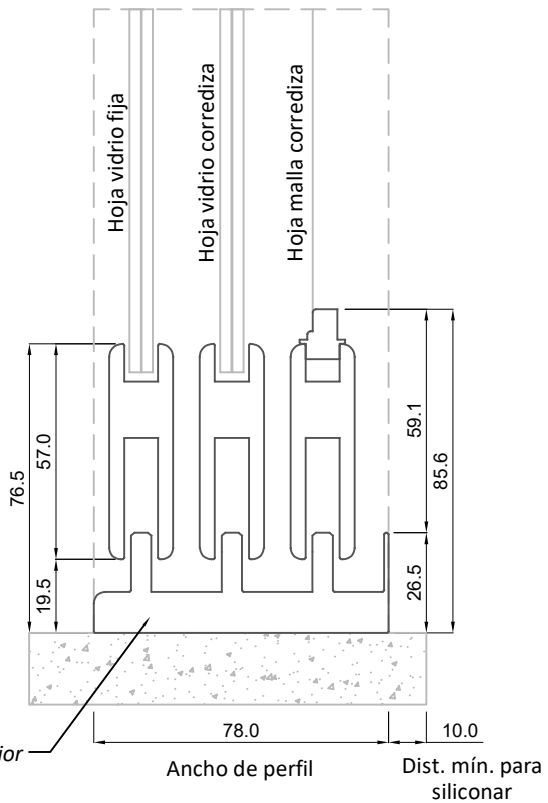
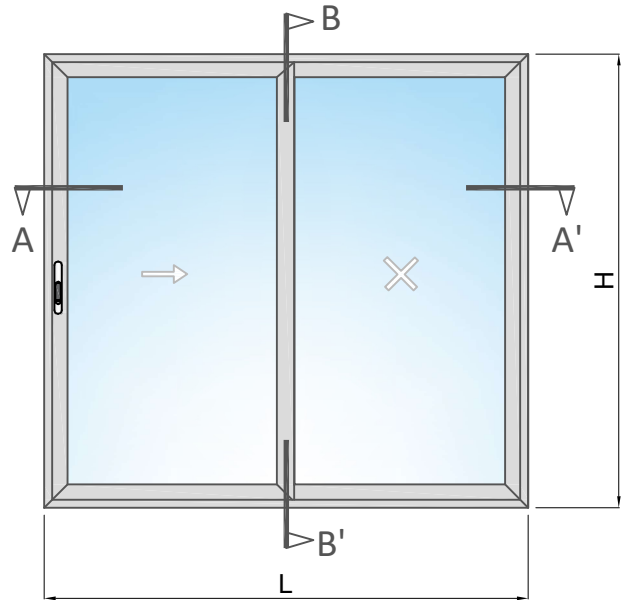

Detalle de espesor de vidrio

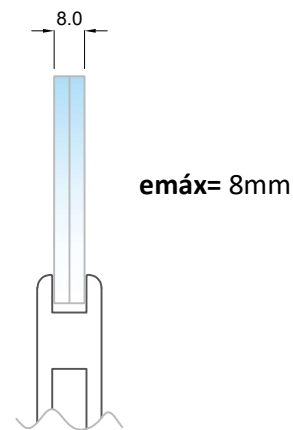

Escala 1:2

Secciones genéricas

Sección A-A'

Corte Horizontal

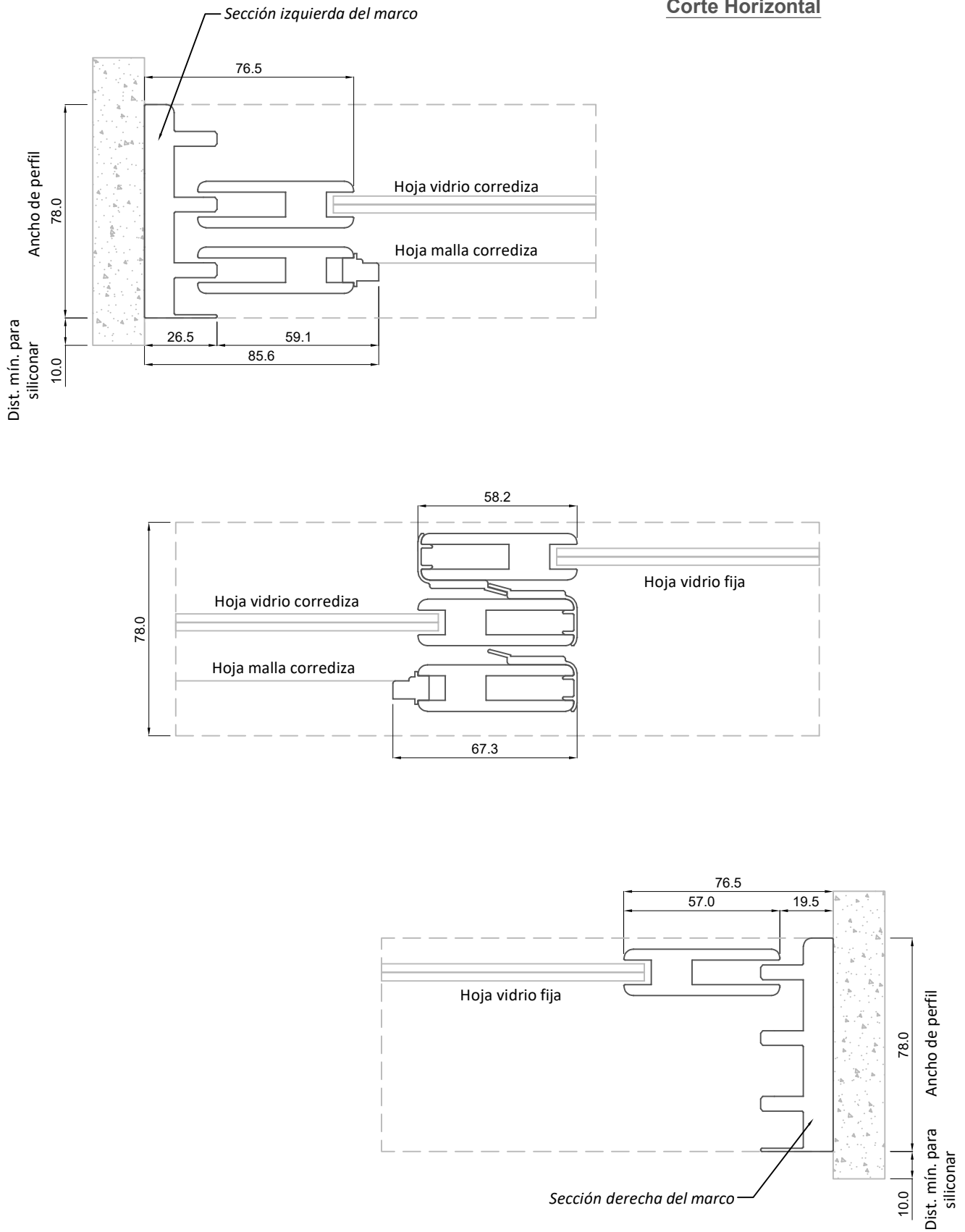

Escala 1:5

Nota:

- La malla es opcional. Al considerarse sin malla se usaría el marco de 2 rieles FI-3880.

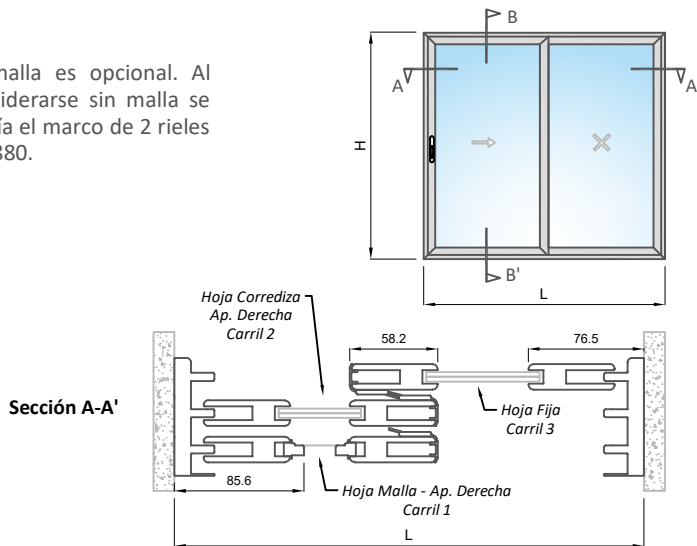

Eurolight 3 carriles

Sistema 2 hojas + Malla

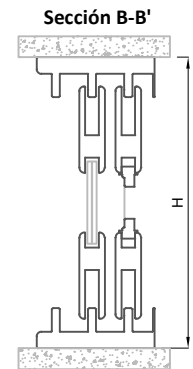

Escala 1:5

Nota:

- La malla es opcional.

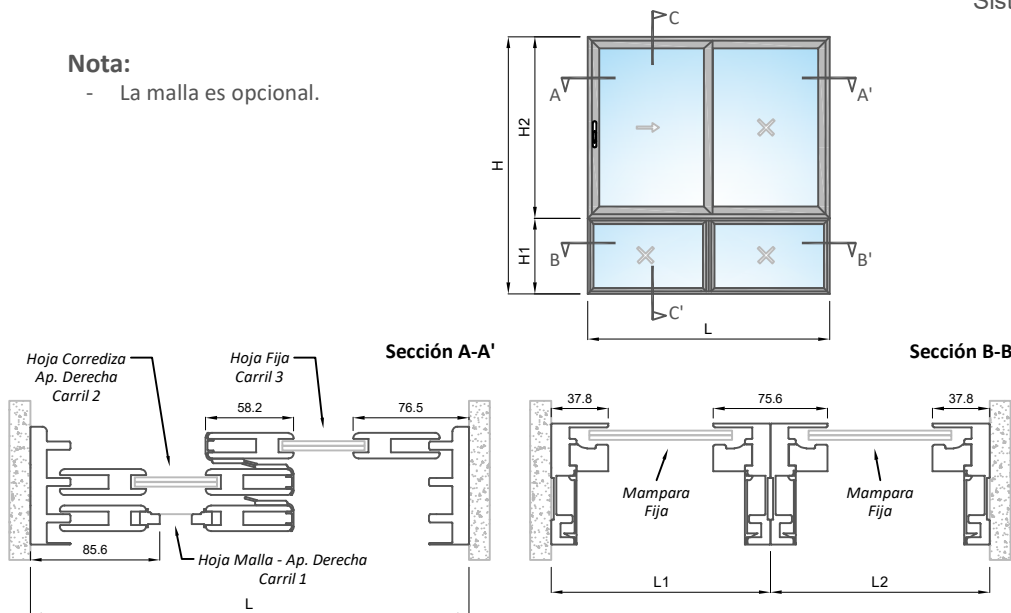

Eurolight 3 carriles

Sistema 2 hojas + Malla + Fijo inferior

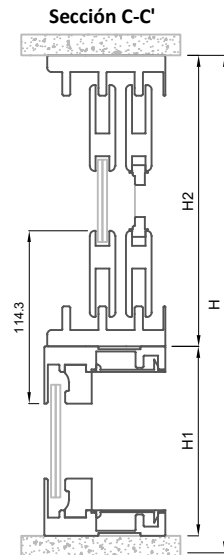

Escala 1:5

Nota:

- La malla es opcional. Al considerarse sin malla se usaría 1 riel menos.

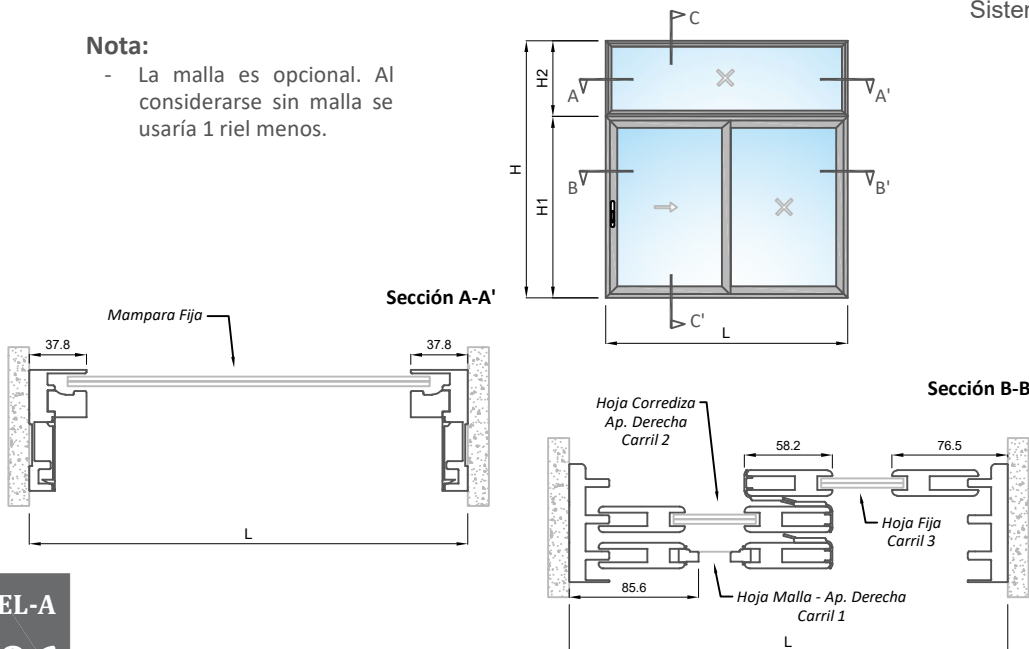

Eurolight 3 carriles

Sistema 2 hojas + Malla + Fijo superior

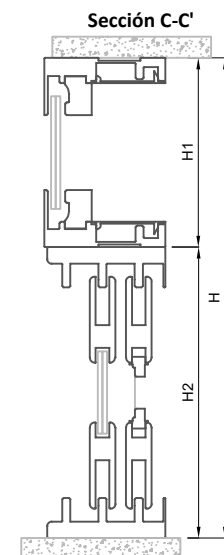

Eurolight 3 carriles

Escala 1:5

Sistema 3 hojas sin malla

Nota:

- La malla es opcional. Al considerarse sin malla se usaría el marco de 2 rieles FI-3880.

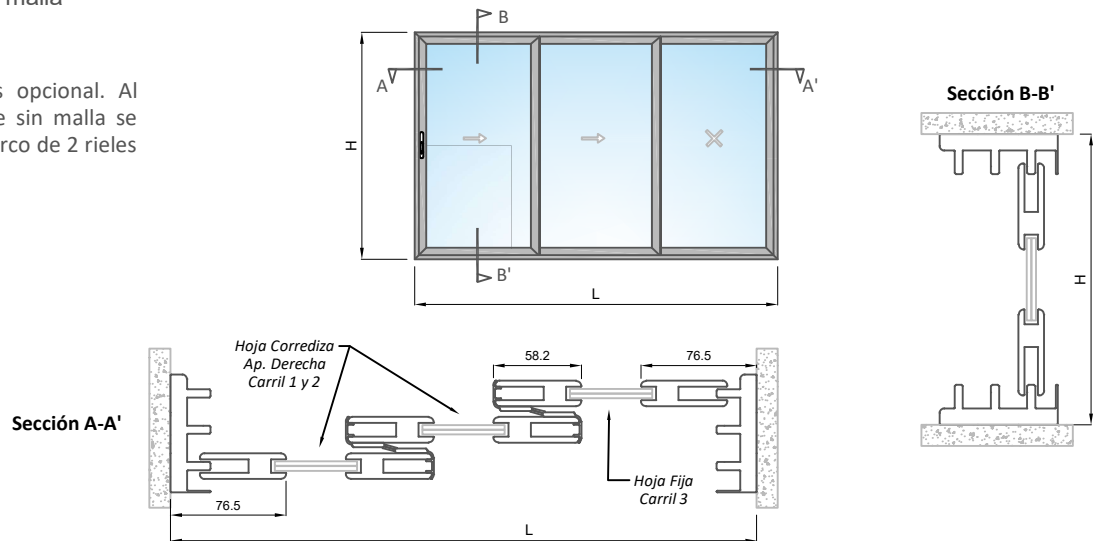

Eurolight 3 carriles

Escala 1:5

Sistema 3 hojas + Malla

Nota:

- La malla es opcional. Al considerarse sin malla se usaría el marco de 2 rieles FI-3880.

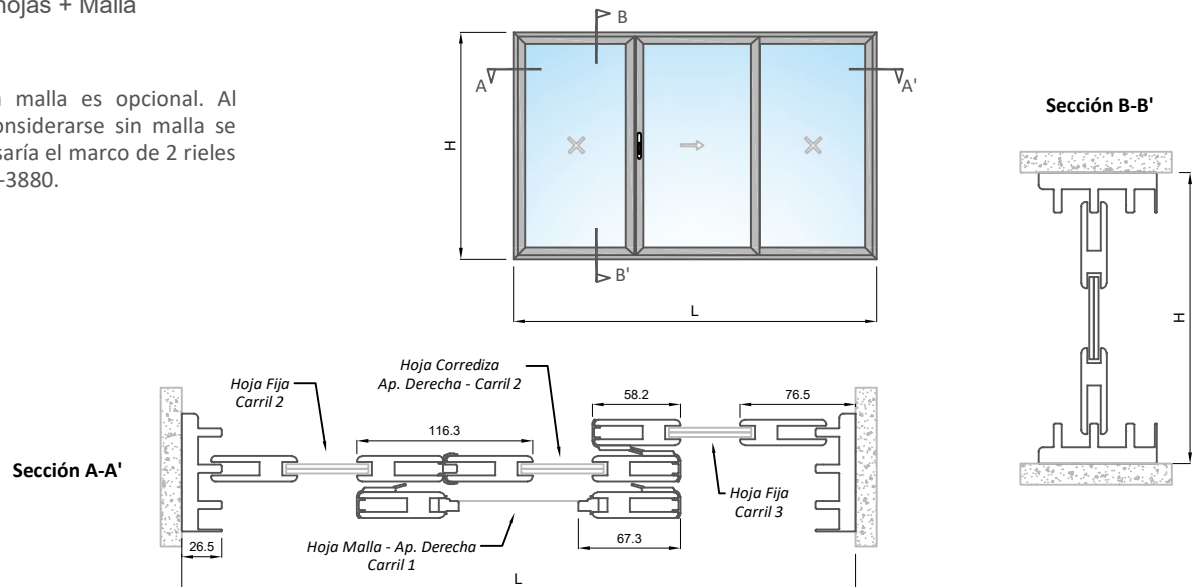

Eurolight 3 carriles

Escala 1:5

Sistema 3 hojas + 2 Mallas

Nota:

- La malla es opcional. Al considerarse sin malla se usaría el marco de 2 rieles FI-3880.

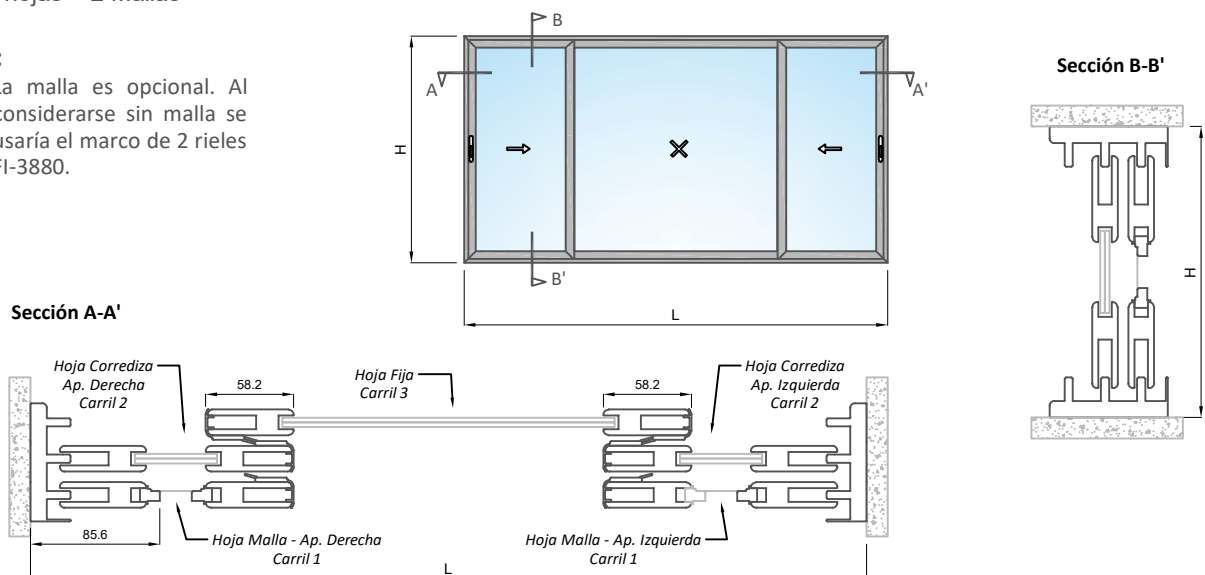

Eurolight 3 carriles

Escala 1:5

Sistema 4 hojas + 2 Mallas

Nota:

- La malla es opcional. Al considerarse sin malla se usaría el marco de 2 rieles FI-3880.

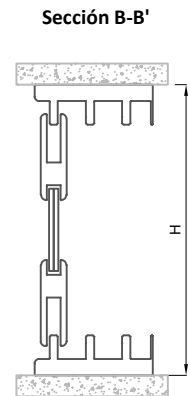
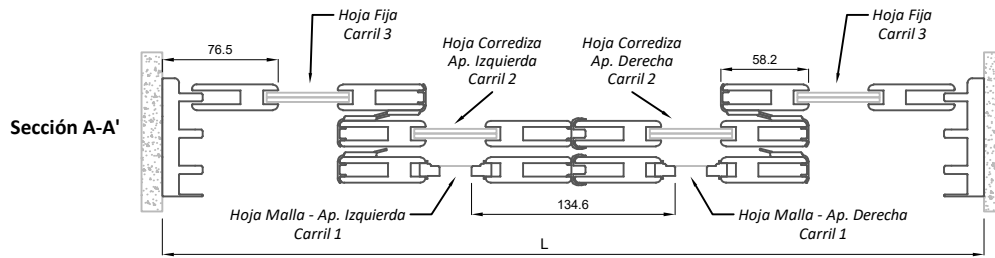
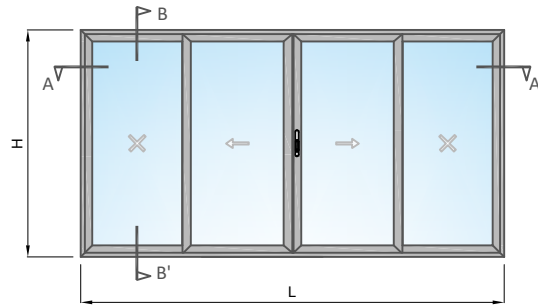

Detalles de cortes de piso

Escala 1:2

Secciones genéricas

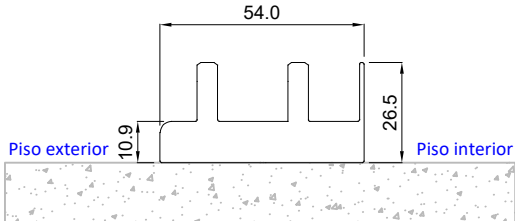
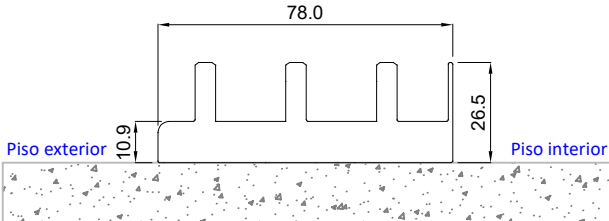
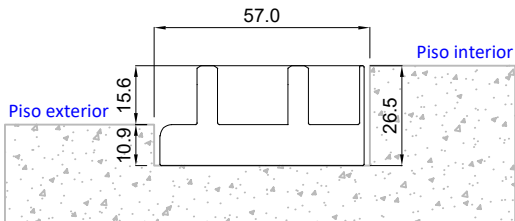
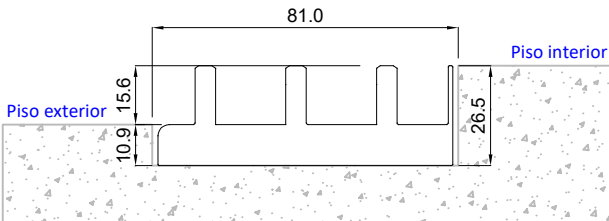
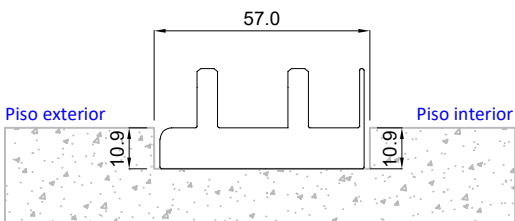
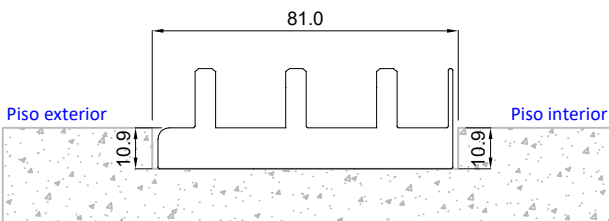
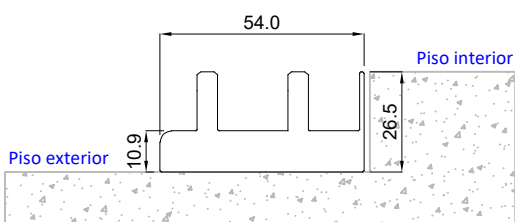
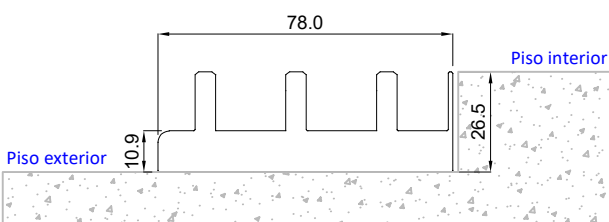
	EL - 2 Rieles	EL - 3 Rieles
Opción #1		
Opción #2		
Opción #3		
Opción #4		
Opción #5	