



Sistema Evolution

Puertas

Window World



**CATALOGO GENERAL DEL SISTEMA
EVOLUTION**

ÍNDICE

Generalidades.....	2
Configuraciones posibles.....	2
Secciones de perfiles.....	3
Ensamble:	
Sistema 2 hojas corrediza por interior.....	8
Sistema 3 hojas con corrediza por exterior.....	8
Sistema 3 hojas con corrediza por interior	10
Sistema 4 hojas con corredizas por exterior.....	11
Sistema 4 hojas con corredizas por interior	12
Malla mosquitera.....	13
Detalles de cortes de piso.....	14

GENERALIDADES DEL SISTEMA EVOLUTION

	Mínimo	Máximo
Alto de la hoja:		
Ancho de la hoja:		

Dimensión del perfil de hoja:	
Dimensión del perfil de marco:	
Peso máximo:	
Espesor máximo de vidrio:	

CONFIGURACIONES POSIBLES

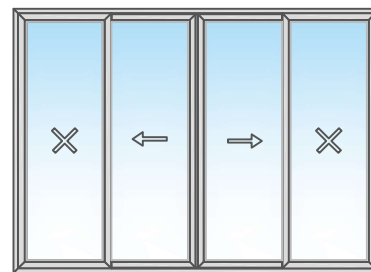
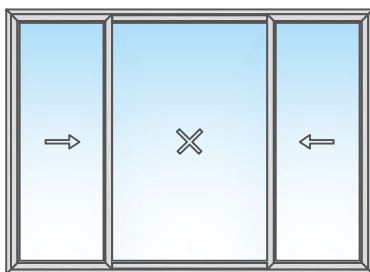
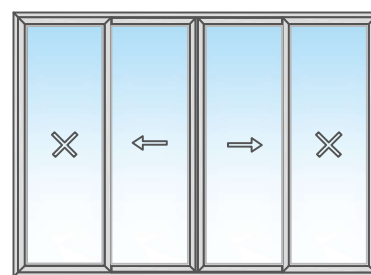
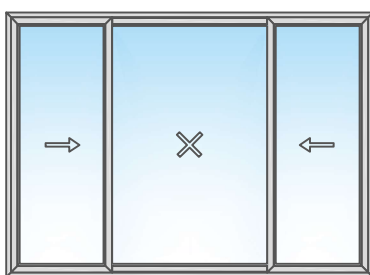
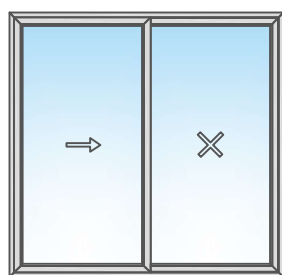

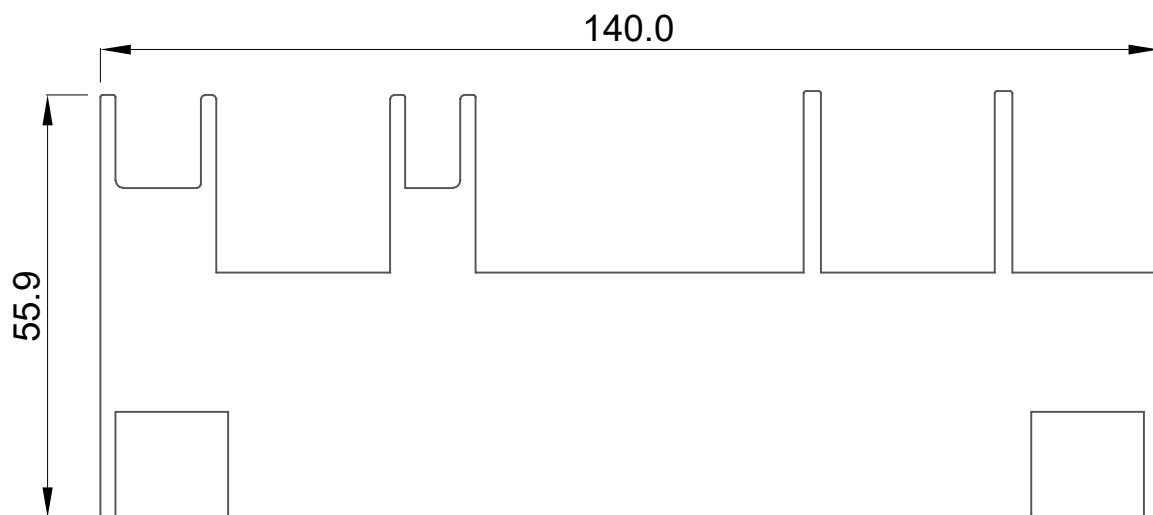

FI-5929
MARCO

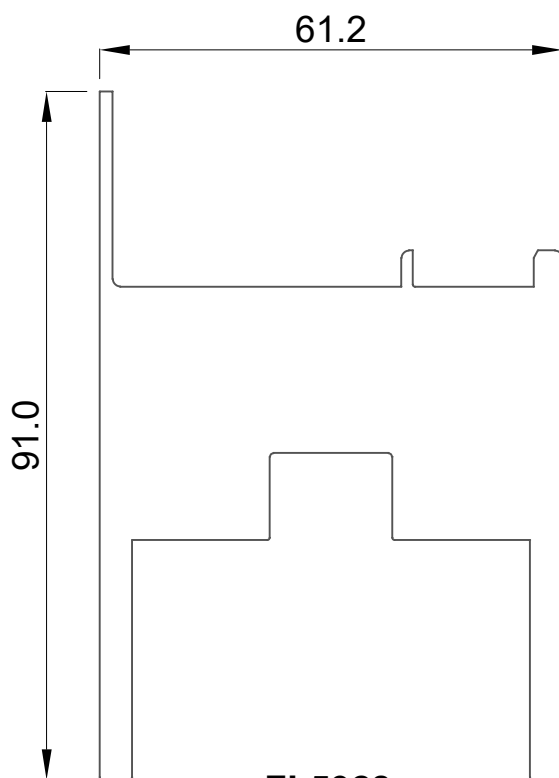

FI-5928
HOJA

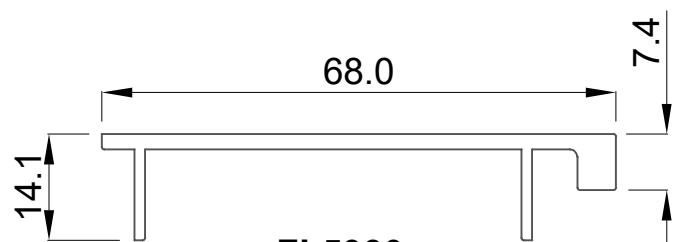

FI-5930
TAPA DE HOJA

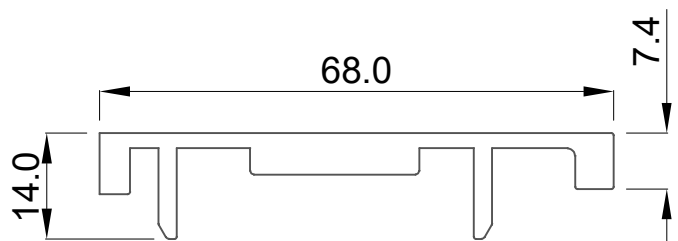

FI-5931
TAPA DE HOJA

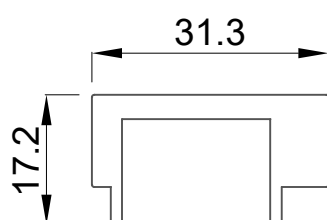

FI-5933
PERFIL DE CERRADEROS

Secciones genéricas

Escala 1:1

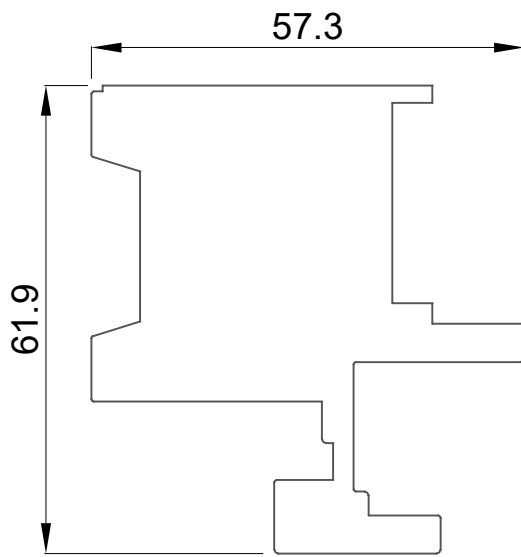

FI-5949
ADAPTADOR DE HOJAS

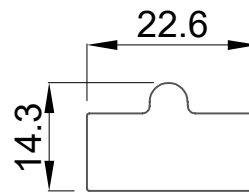

FI-5932
RIEL

Secciones genéricas

Escala 1:2

Sección A-A'

Corte Vertical

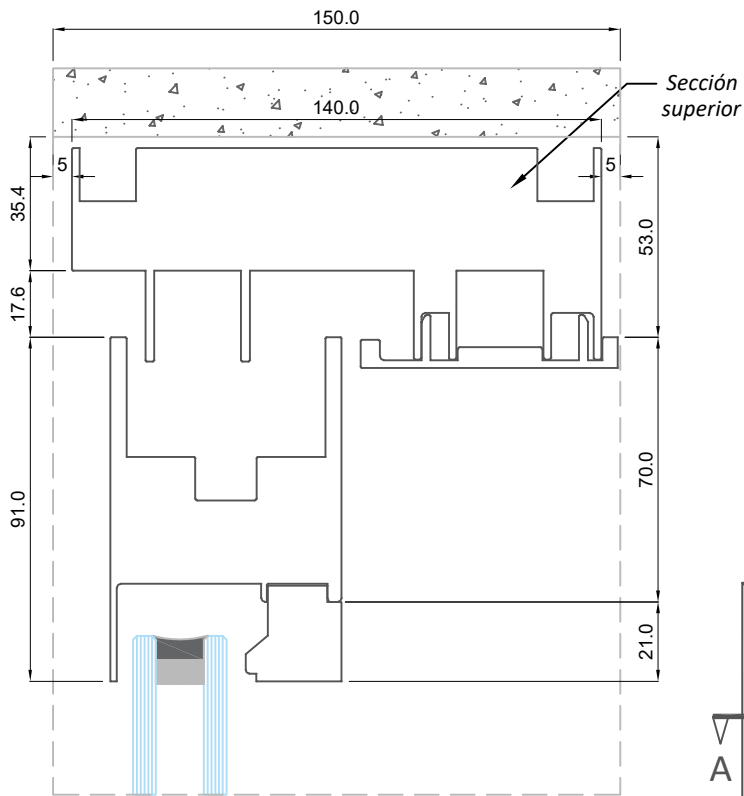

Puerta Genérica
Visto por interior
Apertura: Corrediza por exterior
Opción: 2 hojas

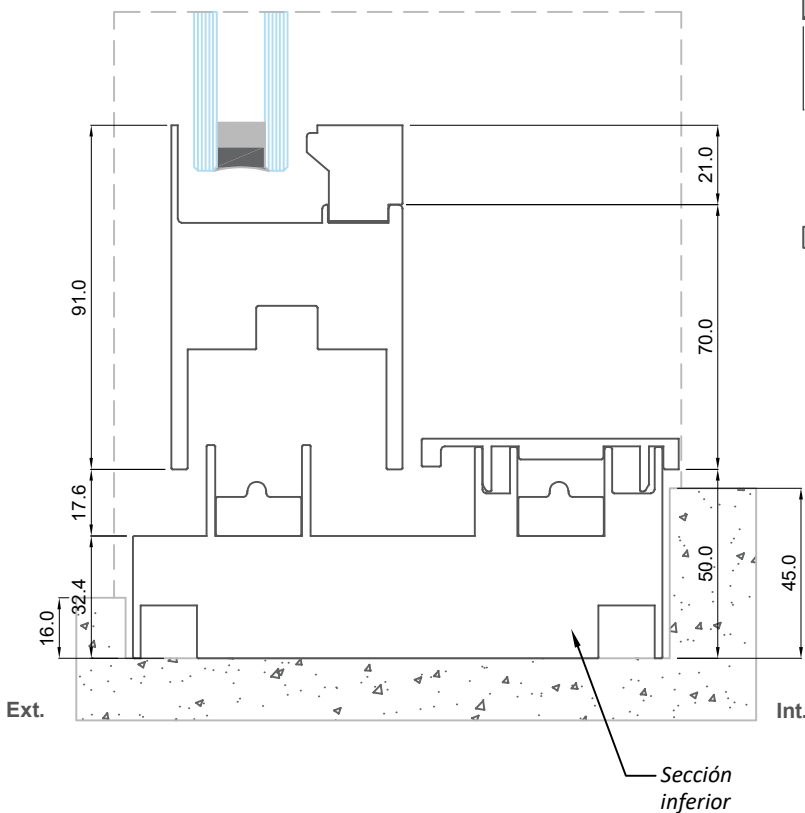
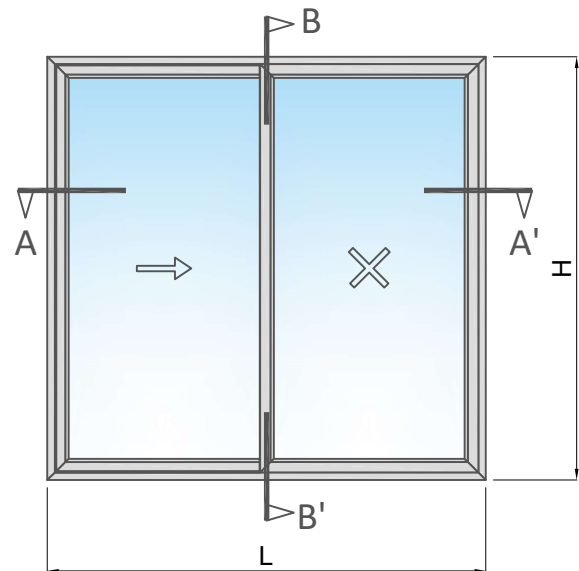

Unidades en milímetros

Secciones genéricas

Escala 1:1

Sección B-B'

Corte Horizontal

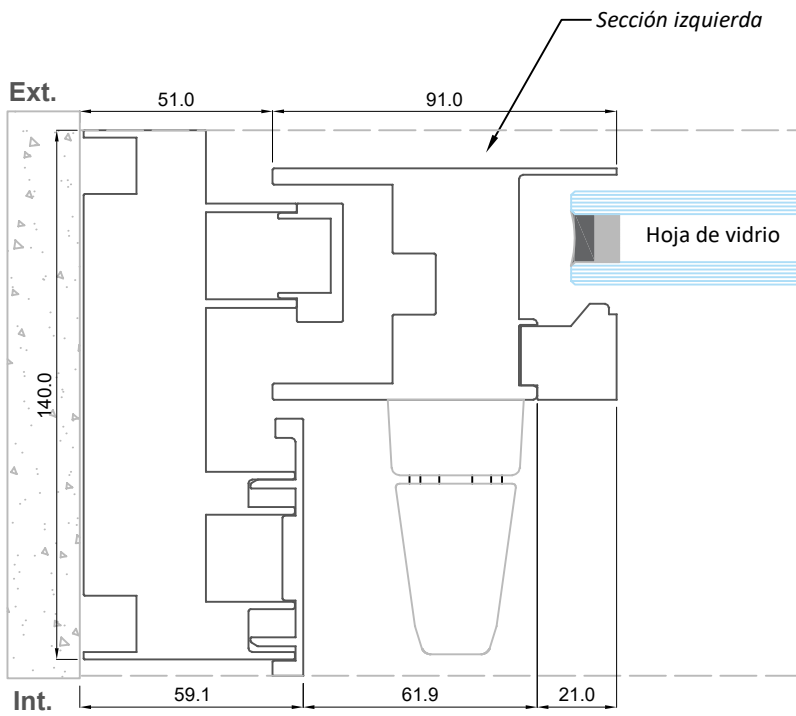

Sección central

Secciones genéricas

Escala 1:1

Sección B-B'

Corte Horizontal

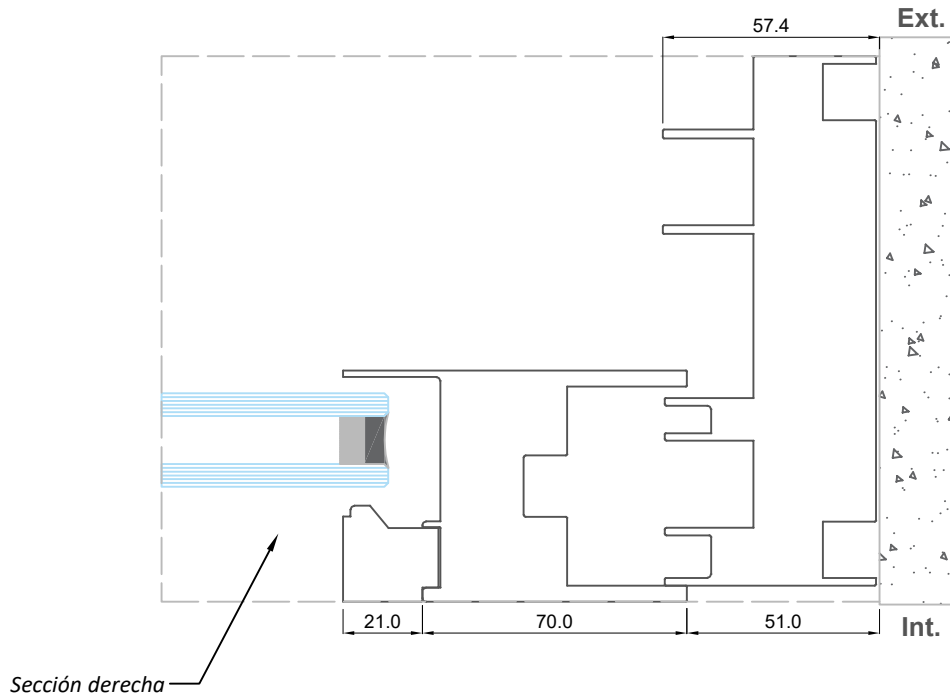

Puerta Evolution

Escala 1:5

Sistema 2 hojas - Corrediza por interior

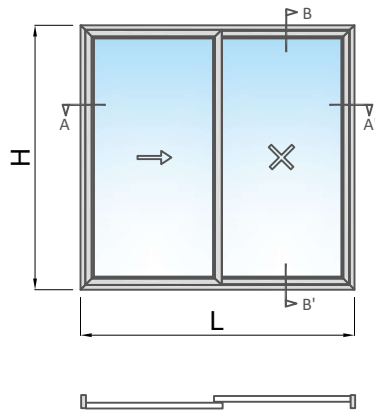

Sección B-B'

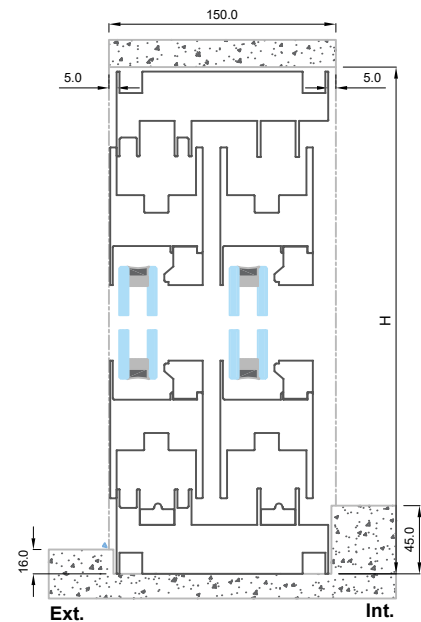

Sección A-A'

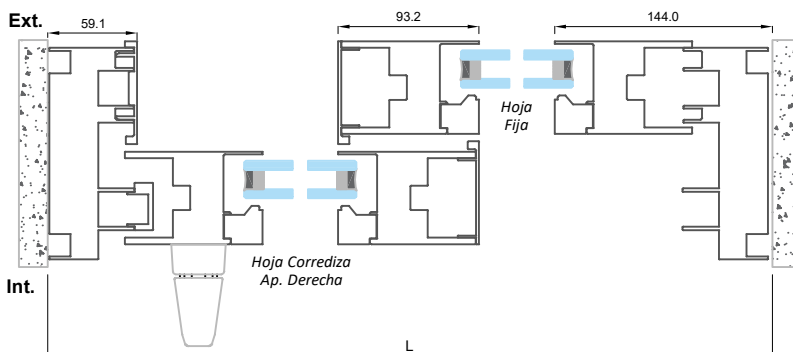

Puerta Evolution

Escala 1:5

Sistema 3 hojas - Corrediza por exterior

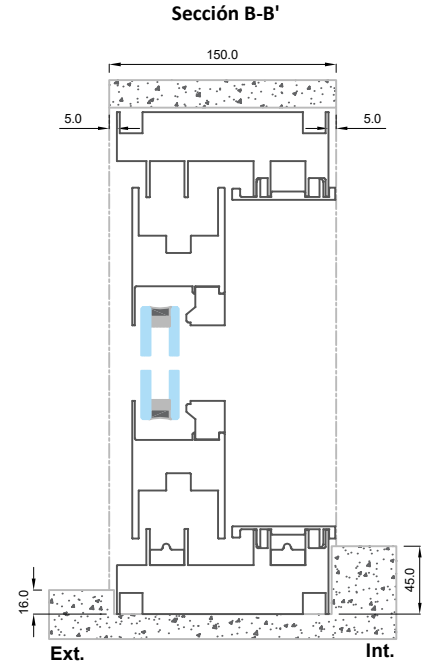
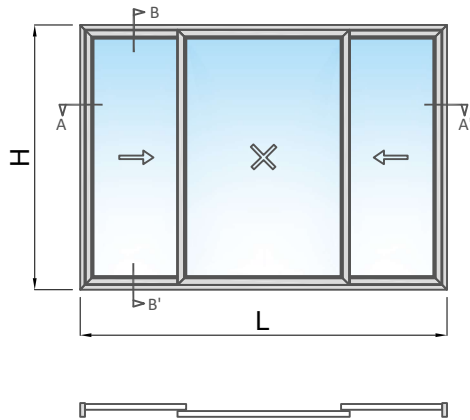

Sección A-A'

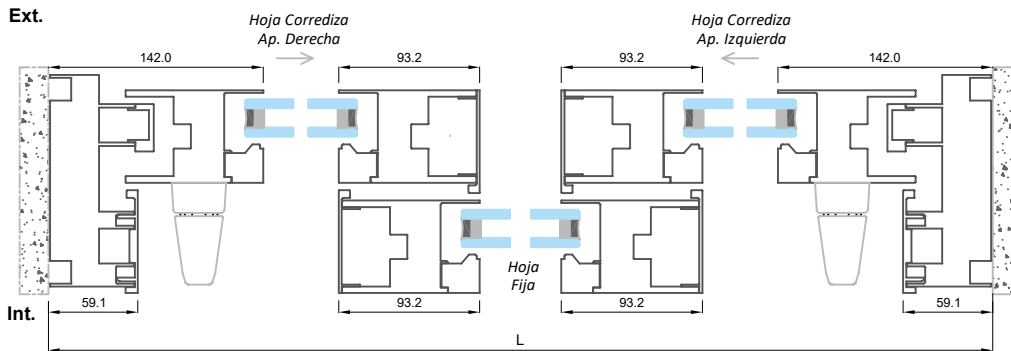

Puerta Evolution

Escala 1:5

Sistema 3 hojas - Corrediza por interior

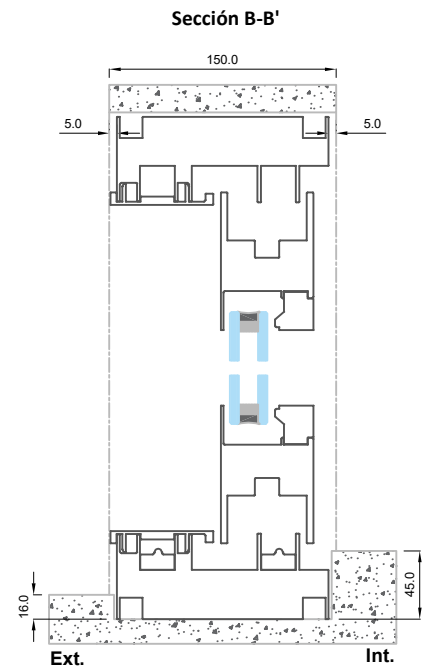
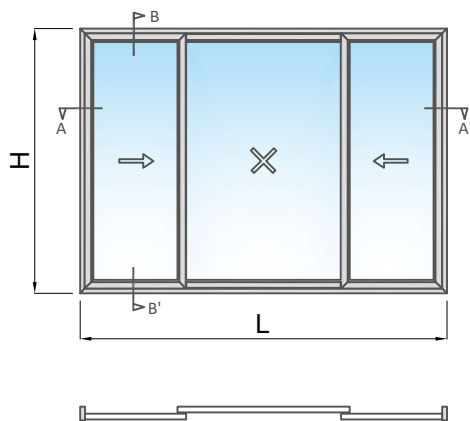

Sección A-A'

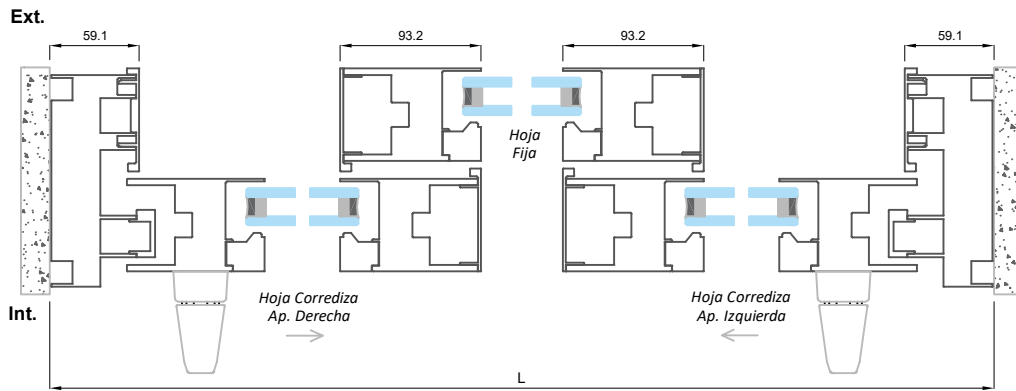

Puerta Evolution

Escala 1:5

Sistema 4 hojas - Corrediza por exterior

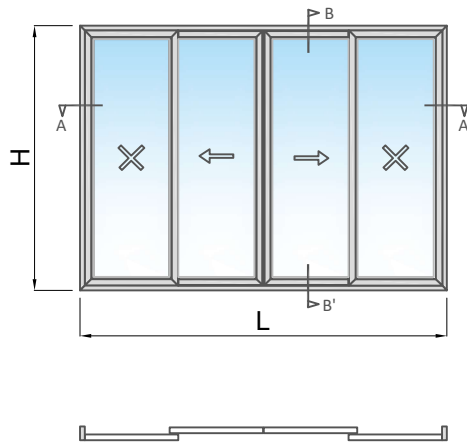

Sección B-B'

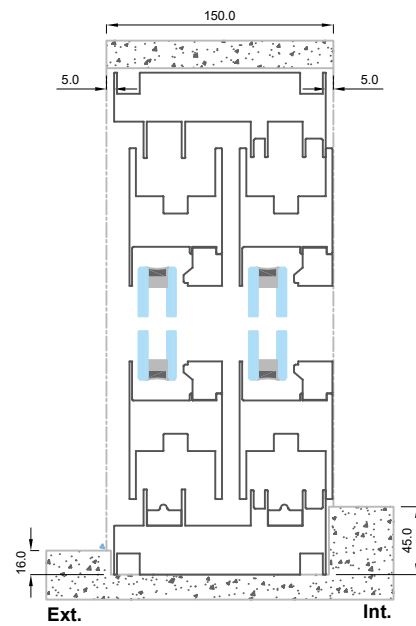

Sección A-A'

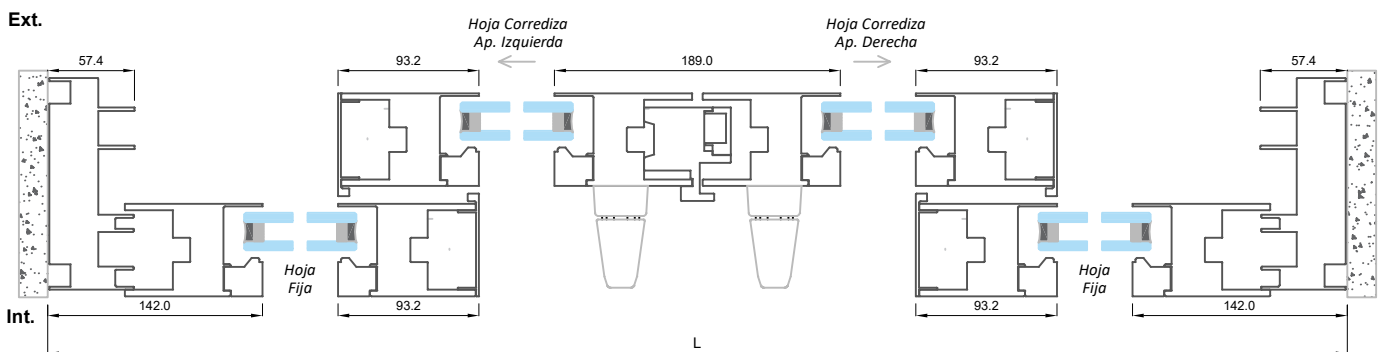

Puerta Evolution

Escala 1:5

Sistema 4 hojas - Corrediza por interior

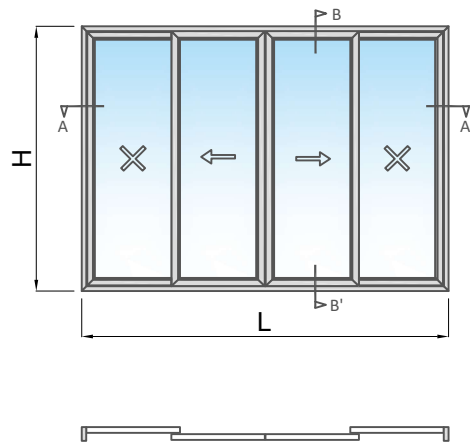

Sección B-B'

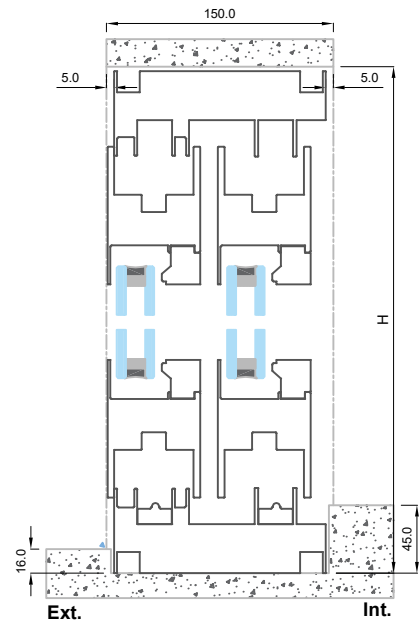

Sección A-A'

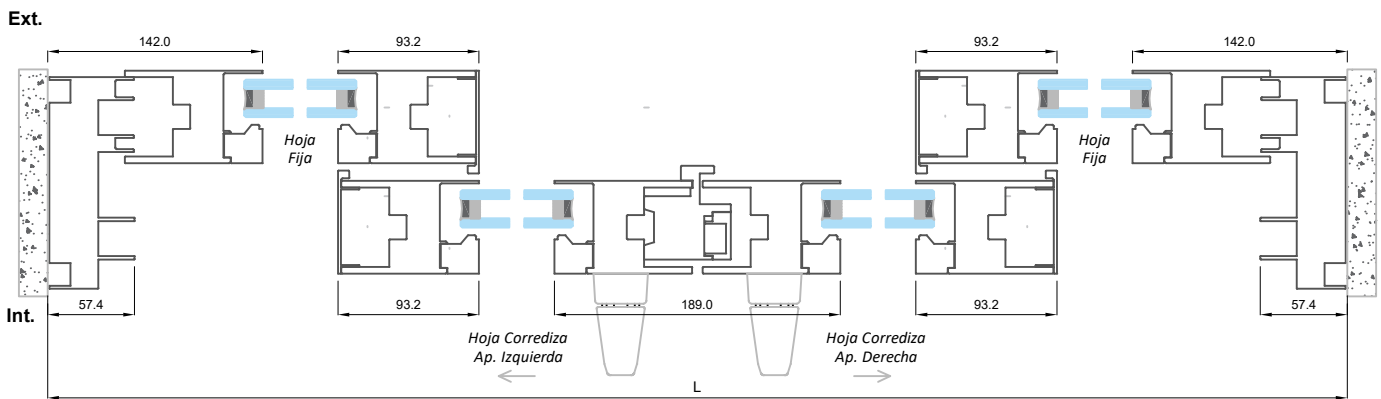

Puerta Evolution

Escala 1:5

Malla mosquitera - Perfiles Evolution

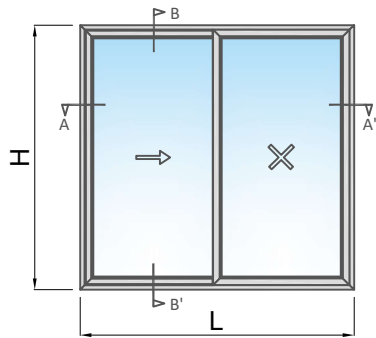

Sección A-A'
Ext.

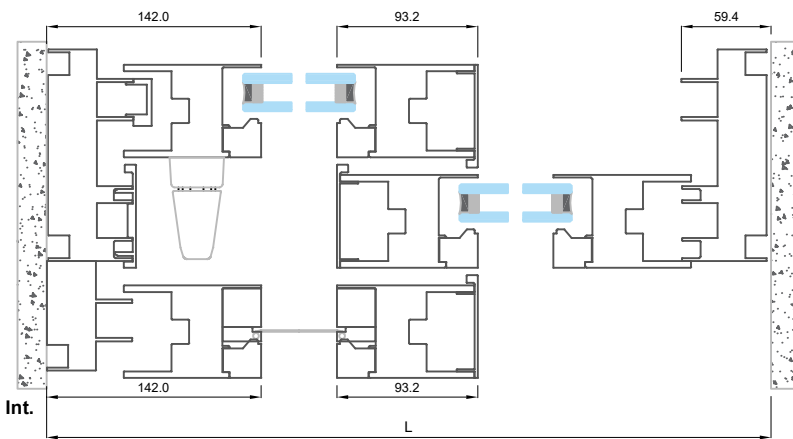

Sección B-B'

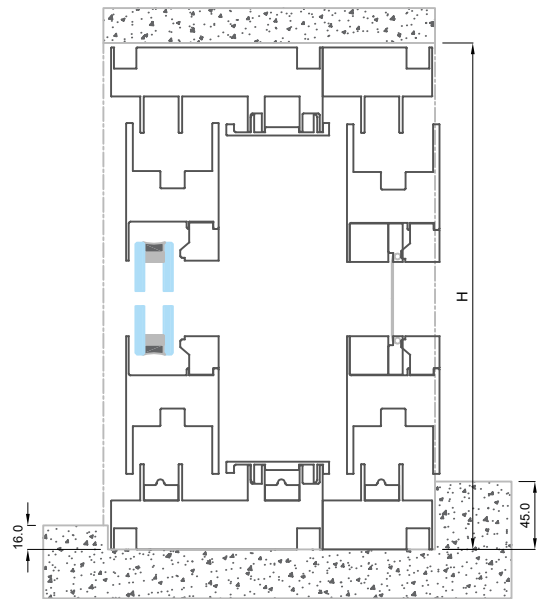

Escala 1:2

Secciones genéricas

Detalles de cortes de piso

Puerta corrediza por exterior

Desnivel
mínimo 30mm
Se puede usar junto a boquetes
con sistemas corredizos opción # 6

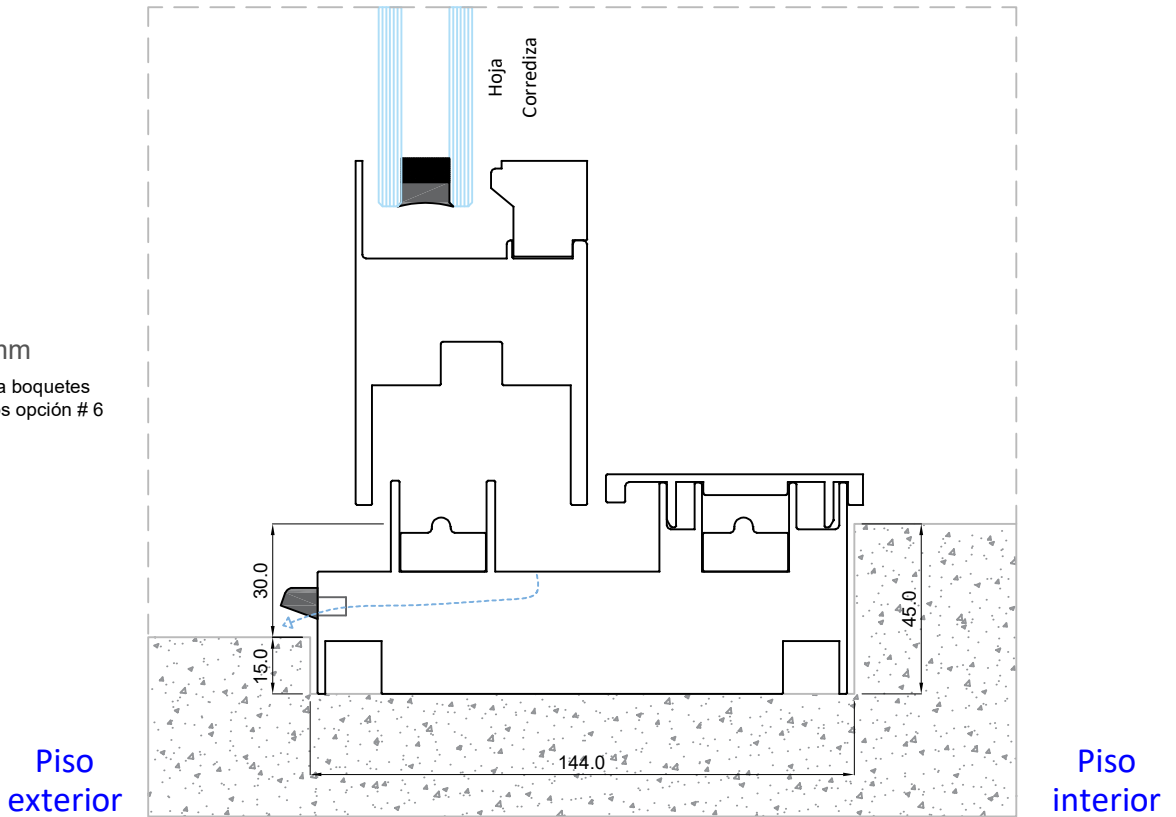

Puerta corrediza por interior

Desnivel
mínimo 30mm
Se puede usar junto a boquetes
con sistemas corredizos opción # 6

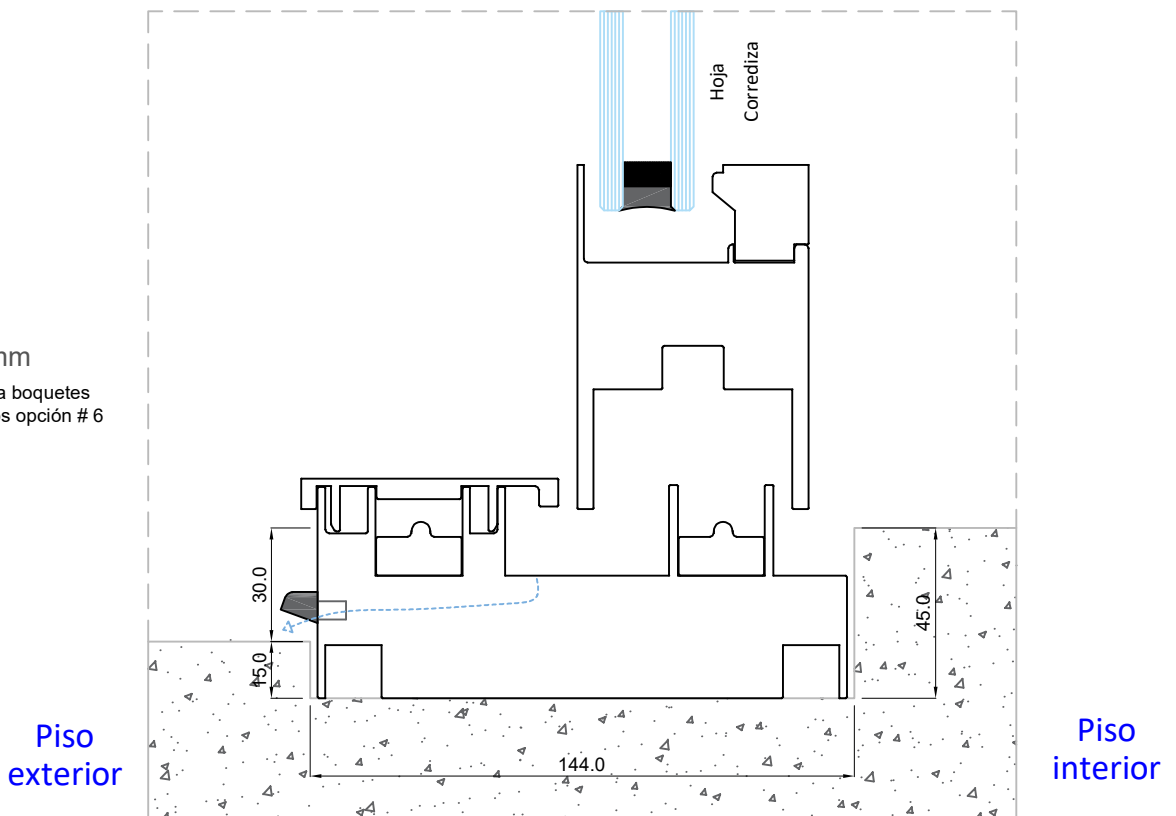

Secciones genéricas

Escala 1:2

Detalles de cortes de piso

Puerta corrediza por interior

Desnivel completo por exterior
Se puede usar junto a boquetes con sistemas corredizos opción # 4

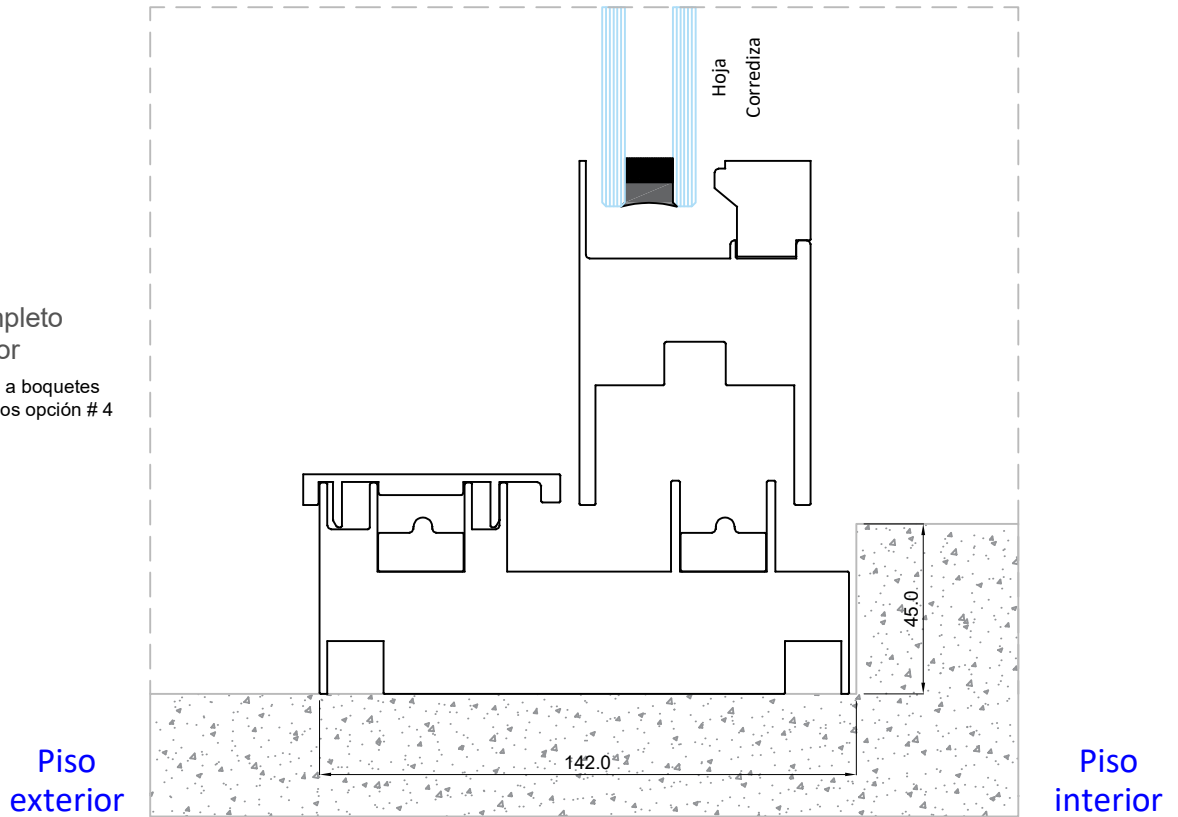

Puerta corrediza por interior

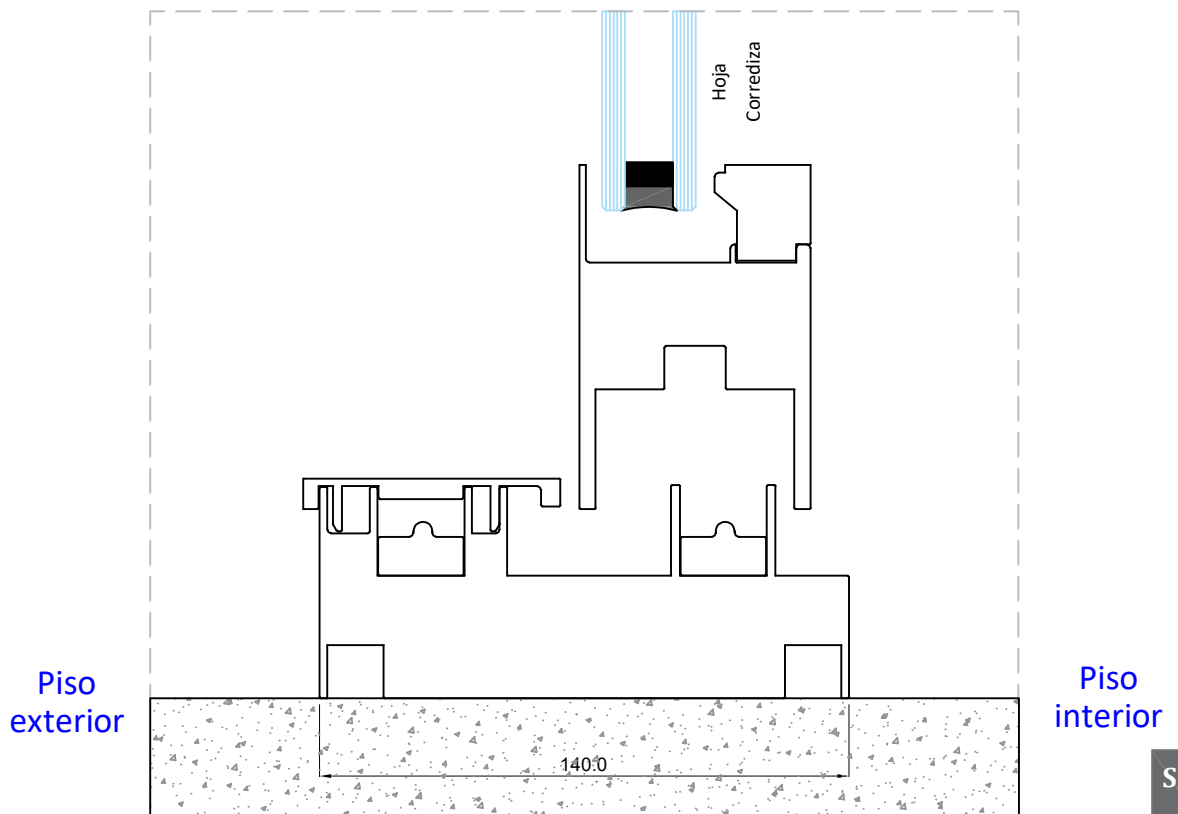

Unidades en milímetros

SE-A

13

Escala 1:2

Secciones genéricas

Detalles de cortes de piso

Puerta corrediza por exterior con malla corrediza - Perfiles Evolution

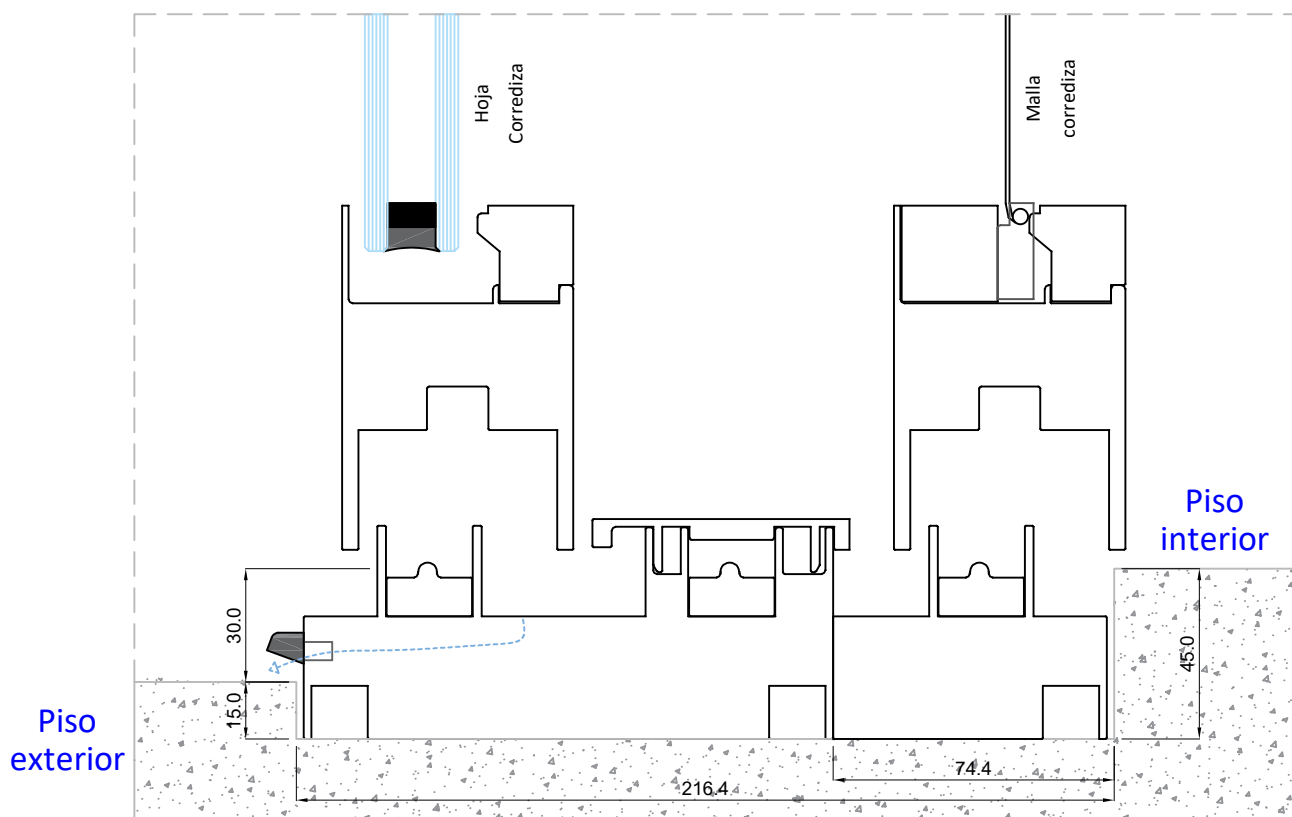

Puerta corrediza por interior con o sin malla enrollable legacy

